

NIMBLE-L SUSPENDED LUMINAIRE 735

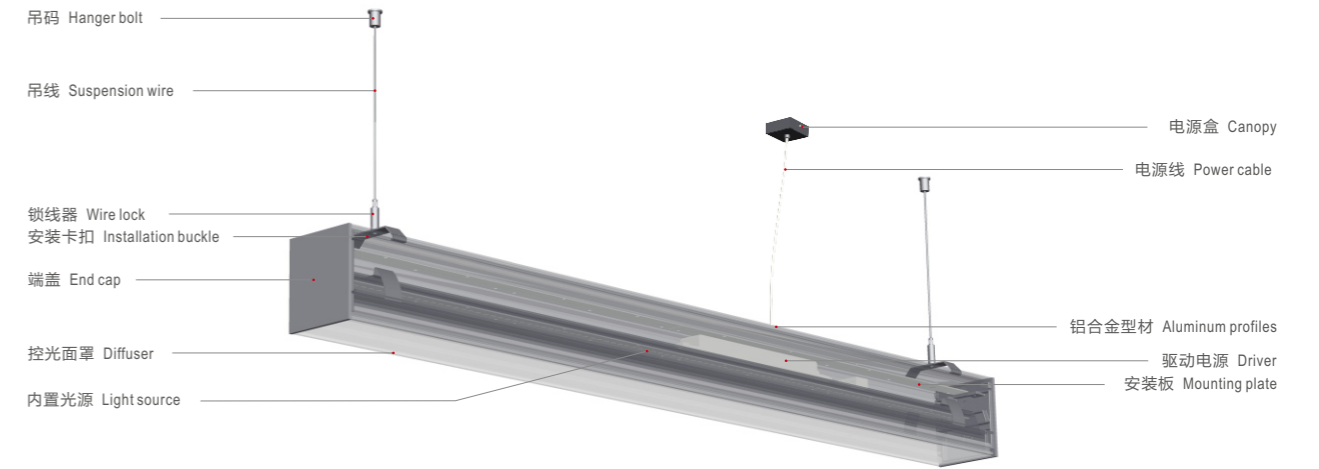

产品细节 Details



规格参数 Technical Data

名称: 735 吊灯
 类型: 吊灯
 灯体材料: 优质铝合金
 表面处理: 静电喷涂
 控光面罩: PMMA
 光源: SMD
 整灯光效: 111 lm/W
 显色指数: ≥83
 色温: 3000K/4000K/6500K
 输入电压: 220-240V
 驱动电源: 高转换率驱动电源
 灯具寿命: 3万小时
 电气等级: I

Product name: 735 Suspended luminaire
Type: Suspended
Housing material: High-quality Aluminum alloy
Surface finish: Electrostatic thermo-painting
Diffuser material: PMMA
Light source: SMD
Luminaire efficiency: 111 lm/W
CRI: ≥83
Color temperature: 3000K / 4000K / 6500K
Input voltage: 220-240V
Driver: High efficiency driver
Lifespan: 30000h
Electrical grade: I

Nimble-L 尼博

735 吊灯/线型光带

Suspended luminaires/
 continuous lighting system technical data sheet

735 尼博线形吊灯为简约式LED灯具，采用优质铝合金型材灯体，无螺丝压铸铝端盖，灯具线条硬朗美观、外观尺寸比例科学，结构合理，安装维护方便灵活。灯具结合了耐贝西创新的直接照明+间接照明的照明理念，运用防眩光灯罩，高透光率扩散型PMMA散光罩根据LED光波长开发，出光均匀无阴影、防眩光效果好，控光面罩与灯体完美结合使整个灯具更加美观。先进的热管理技术，散热优异，确保了灯具最大光输出的持续性及色温的一致性。

应用场所：写字楼、学校、医院、高档超市、商场、酒店等公共建筑。

735 Nimble-L series Suspend mounted linear LED Luminaire, housing made of high pressure extruded aluminum construction, die-cast aluminum end caps with no visible screws, simple and easy installation, excellent heat dissipation. Available with fixed direct distributions and the indirect/direct distributions options, applying anti-glare diffuser and double transmission principle of secondary reflection, Slim Compact series with Germany imported high transmittance PMMA diffuser specially designed for LED light source creating smooth and uniform lighting distributions, without visible dark spot or light gaps in seamless continuous lighting system. Advanced thermal management technology to ensure consistency of LED life span, color temperature and maximize output lumens.

Applications: Offices, Educational Institutes, Hospitals, Warehouses, Hospitality, Retailers Etc.

Indoor 室内适用	General lighting 基础照明	High efficiency 高光效	Long life 长寿命	Anti glare 防眩光	Accurate light distribution 准配光
No flickering 无频闪	IP 20 Protection level 防护等级	Protective grounding 保护接地	Fire protection 防火	Low lumen depreciation 低光衰	color-temp changing 调色温驱动电源
Microwave sensor 微波感应控制	Emergency kits 应急照明组件	DALI	light control 光控	Wifi or Ble, Zigbee	1-10V 1-10V dimming 1-10V调光
China Compulsory Certification 3C认证	CE certification CE认证	CB certification CB认证			

标准灯具 Standard single fitting

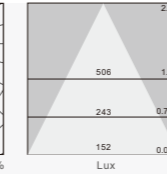
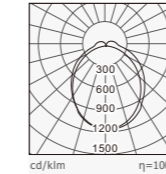
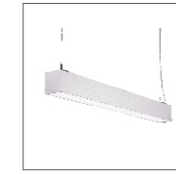
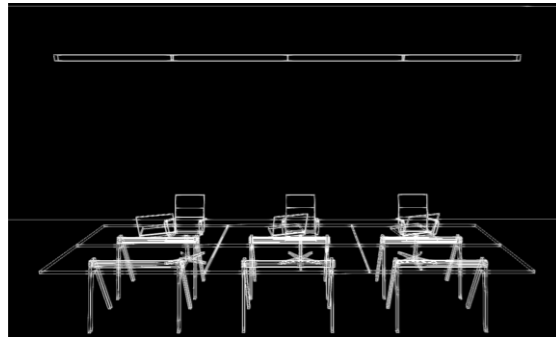

小功率 (HO-L)
CCT: 3000K
Colors: Silver /
White / Black

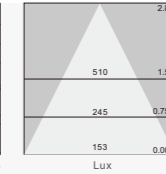
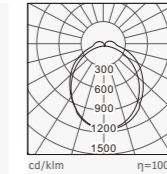

小功率 (HO-L)
CCT: 4000K
Colors: Silver /
White / Black

Item No	Power Flux	L*W*H
735-SS1143T36W	36W / 3996 lm	1143*94*105
735-SS1703T54W	54W / 5994 lm	1703*94*105
735-SS2263T72W	72W / 7992 lm	2263*94*105

Item No	Power Flux	L*W*H
735-SS1143T36W	36W / 4016 lm	1143*94*105
735-SS1703T54W	54W / 6014 lm	1703*94*105
735-SS2263T72W	72W / 8012 lm	2263*94*105

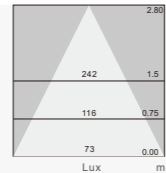
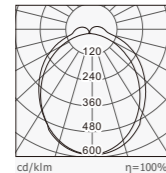
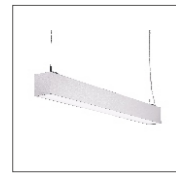

低功率 (HE)
CCT: 3000K
Colors: Silver /
White / Black

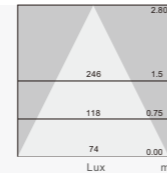
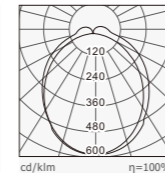

低功率 (HE)
CCT: 4000K
Colors: Silver /
White / Black

Item No	Power Flux	L*W*H
735-SS1143T18W	18W / 1998 lm	1143*94*105
735-SS1703T27W	27W / 2997 lm	1703*94*105
735-SS2263T36W	36W / 3996 lm	2263*94*105

Item No	Power Flux	L*W*H
735-SS1143T18W	18W / 2018 lm	1143*94*105
735-SS1703T27W	27W / 3017 lm	1703*94*105
735-SS2263T36W	36W / 4016 lm	2263*94*105

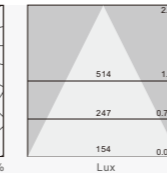
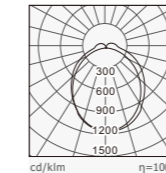
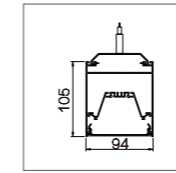

小功率 (HO-L)
CCT: 6500K
Colors: Silver /
White / Black

Item No	Power Flux	L*W*H
735-SS1143T36W	36W / 4036 lm	1143*94*105
735-SS1703T54W	54W / 6034 lm	1703*94*105
735-SS2263T72W	72W / 8032 lm	2263*94*105

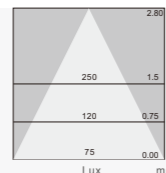
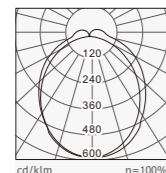
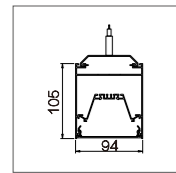

低功率 (HE)
CCT: 6500K
Colors: Silver /
White / Black

Item No	Power Flux	L*W*H
735-SS1143T18W	18W / 2038 lm	1143*94*105
735-SS1703T27W	27W / 3037 lm	1703*94*105
735-SS2263T36W	36W / 4036 lm	2263*94*105

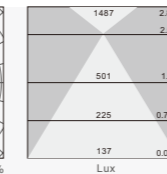
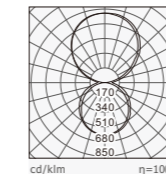
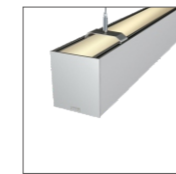

低功率 (HE)
CCT: 3000K
Colors: Silver /
White / Black

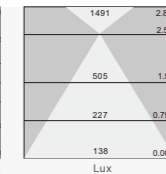
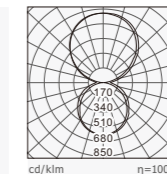

低功率 (HE)
CCT: 4000K
Colors: Silver /
White / Black

Item No	Power Flux	L*W*H
735U-SS1143T36W	36W / 3996 lm	1143*94*105
735U-SS1703T54W	54W / 5994 lm	1703*94*105
735U-SS2263T72W	72W / 7992 lm	2263*94*105

Item No	Power Flux	L*W*H
735U-SS1143T36W	36W / 4016 lm	1143*94*105
735U-SS1703T54W	54W / 6014 lm	1703*94*105
735U-SS2263T72W	72W / 8012 lm	2263*94*105

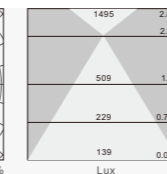
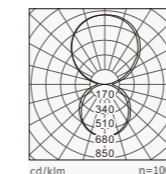
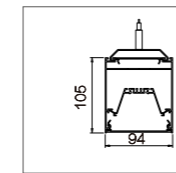
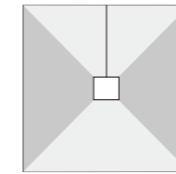

低功率 (HE)
CCT: 6500K
Colors: Silver /
White / Black

Item No	Power Flux	L*W*H
735U-SS1143T36W	36W / 4036 lm	1143*94*105
735U-SS1703T54W	54W / 6034 lm	1703*94*105
735U-SS2263T72W	72W / 8032 lm	2263*94*105

标准灯具 Standard single fitting

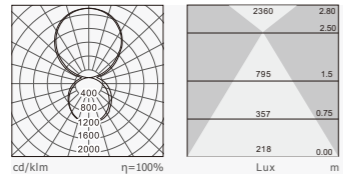

小功率 (HO-L)
CCT: 3000K
Colors: Silver / White / Black

Item No	Power Flux	L*W*H
735U-SS1143T72W	72W / 7992 lm	1143*94*105
735U-SS1703T108W	108W / 11988 lm	1703*94*105
735U-SS2263T144W	144W / 15984 lm	2263*94*105

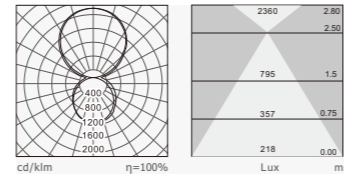
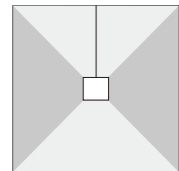

小功率 (HO-L)
CCT: 4000K
Colors: Silver / White / Black

Item No	Power Flux	L*W*H
735U-SS1143T72W	72W / 7992 lm	1143*94*105
735U-SS1703T108W	108W / 11988 lm	1703*94*105
735U-SS2263T144W	144W / 15984 lm	2263*94*105

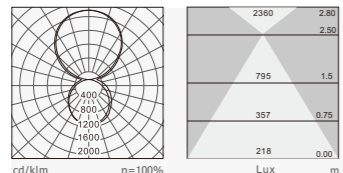
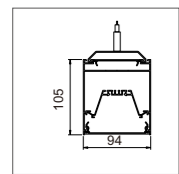

小功率 (HO-L)
CCT: 6500K
Colors: Silver / White / Black

Item No	Power Flux	L*W*H
735U-SS1143T72W	72W / 7992 lm	1143*94*105
735U-SS1703T108W	108W / 11988 lm	1703*94*105
735U-SS2263T144W	144W / 15984 lm	2263*94*105

线形光带示意图 Linear continuous connection demonstration

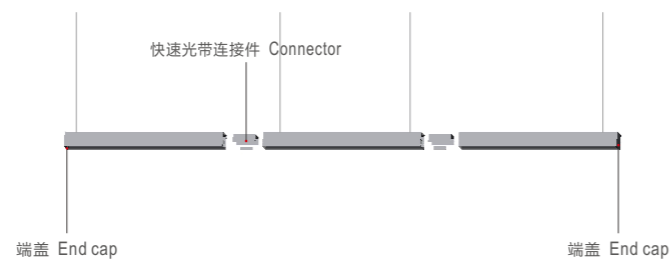

应用参考 Application reference

Open space: 10m x 10m x 3m; reflectance (%): ceiling80/wall50/floor20/ floor ceiling walls; illuminance is the average lux level on 0.75m working surface; "H" is the fittings installation height

开放式空间: 10m x 10m x 3m; 反射率(%): 天花板 80/墙壁50/地板20; 照度为 0.75m工作面平均照度; H为灯具安装离地高度。

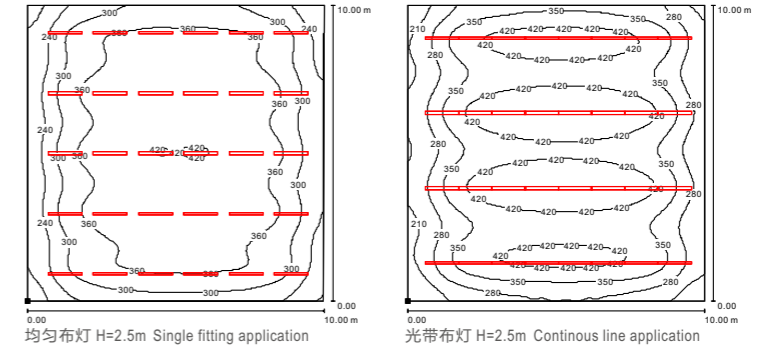

Item No	Power Flux	Number	W/m ²	H=2.8m Illuminance(Lux)
735-SS1143T18W	18W / 1998 lm	30	5.4	338
735-SS8983T144W	144W / 15984 lm	4	5.76	364



→
Nimble-L
尼博系列
735吊灯
办公场所实景图