

产品细节 Details

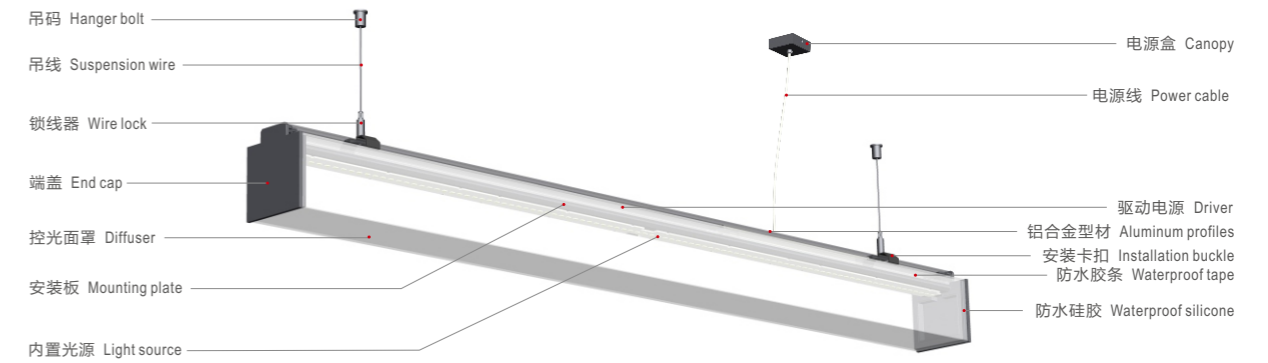

规格参数 Technical Data

名称: 703 吊灯
 类型: 吊灯
 灯体材料: 优质铝合金
 表面处理: 静电喷涂
 控光面罩: PMMA
 光源: SMD
 整灯光效: 128 lm/W
 显色指数: ≥83
 色温: 3000K / 4000K / 6500K
 输入电压: 220-240V
 驱动电源: 高转换率驱动电源
 灯具寿命: 3万小时
 电气等级: I

Product name: 703 Suspended luminaire
Type: Suspended
Housing material: High-quality Aluminum alloy
Surface finish: Electrostatic thermo-painting
Diffuser material: PMMA
Light source: SMD
Luminaire efficiency: 128 lm /W
CRI: ≥83
Color temperature: 3000K / 4000K / 6500K
Input voltage: 220-240V
Driver: High efficiency driver
Lifespan: 30000h
Electrical grade: I

Niman 尼曼

703 吊灯

Suspended luminaires technical data sheet

703 系列线型吊灯, 外观简约大方, 采用优质线形铝型材灯体, 无螺丝压铸铝端盖, 灯体轻, 散热优异。方管形透光罩可提供270度照明、出光均匀无阴影。先进的热管理技术确保了灯具最大光输出的持续性及色温的一致性。
 应用场所: 写字楼, 学校、医院、高档超市、商场、公共建筑等。

703 series linear light, simple and concise look, high quality extruded aluminum housing, die-cast aluminum end caps with no visible screws and square tubular diffuser which provides 270° illumination and smooth uniform appearance. Advanced Thermal Management ensures maximum lumen maintenance and consistent color temperature.

Application: offices, Educational Institutes, Hospitals, Warehouses, Hospitality, Retails, etc

Indoor 室内适用	General lighting 基础照明	High efficiency 高光效	Long life 长寿命	Anti glare 防眩光	Accurate light distribution 准配光
No flickering 无频闪	IP 54 Protection level 防护等级	Protective grounding 保护接地	Fire protection 防火	Low lumen depreciation 低光衰	color-temp changing 调色温驱动电源
Microwave sensor 微波感应控制	Emergency kits 应急照明组件	DALI	light control 光控	Wifi or Ble, Zigbee	1-10V 1-10V dimming 1-10V调光
China Compulsory Certification 3C认证	CE certification CE认证	CB certification CB认证			

标准灯具 Standard single fitting

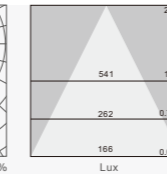
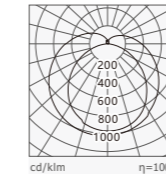
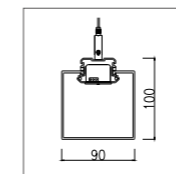
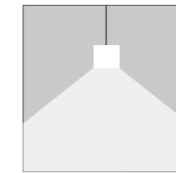
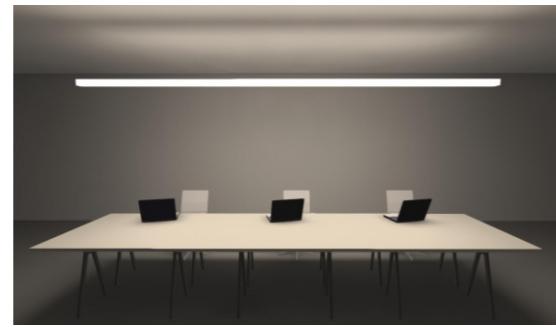
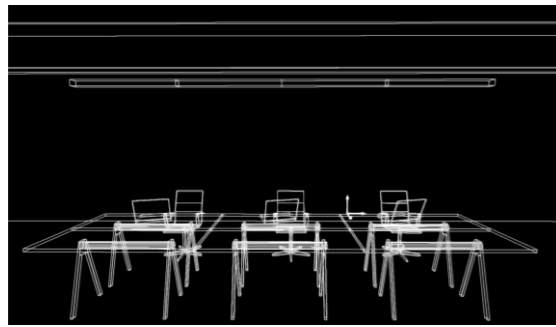

小功率 (HO-L)
CCT: 3000K
Colors: Silver /
White / Black

Item No	Power Flux	L*W*H
703-SS1147T36W	36W / 4608 lm	1147*90*100
703-SS1707T54W	54W / 6912 lm	1707*90*100
703-SS2267T72W	72W / 9216 lm	2267*90*100

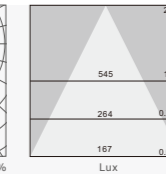
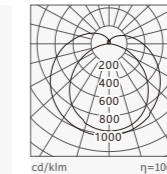

小功率 (HO-L)
CCT: 4000K
Colors: Silver /
White / Black

Item No	Power Flux	L*W*H
703-SS1147T36W	36W / 4628 lm	1147*90*100
703-SS1707T54W	54W / 6932 lm	1707*90*100
703-SS2267T72W	72W / 9236 lm	2267*90*100

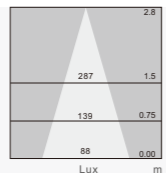
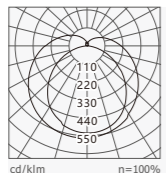

低功率 (HE)
CCT: 3000K
Colors: Silver /
White / Black

Item No	Power Flux	L*W*H
703-SS1147T18W	18W / 2304 lm	1147*90*100
703-SS1707T27W	27W / 3456 lm	1707*90*100
703-SS2267T36W	36W / 4608 lm	2267*90*100

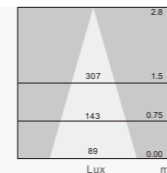
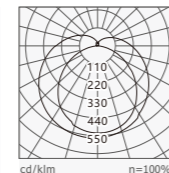

低功率 (HE)
CCT: 4000K
Colors: Silver /
White / Black

Item No	Power Flux	L*W*H
703-SS1147T18W	18W / 2324 lm	1147*90*100
703-SS1707T27W	27W / 3476 lm	1707*90*100
703-SS2267T36W	36W / 4628 lm	2267*90*100

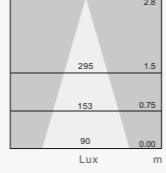
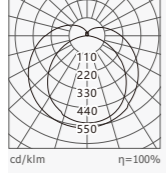
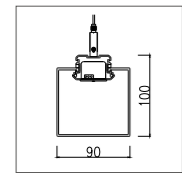

低功率 (HE)
CCT: 6500K
Colors: Silver /
White / Black

Item No	Power Flux	L*W*H
703-SS1147T18W	18W / 2344 lm	1147*90*100
703-SS1707T27W	27W / 3496 lm	1707*90*100
703-SS2267T36W	36W / 4648 lm	2267*90*100

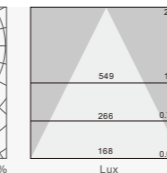
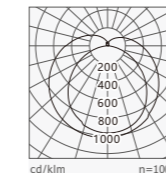

小功率 (HO-L)
CCT: 6500K
Colors: Silver /
White / Black

Item No	Power Flux	L*W*H
703-SS1147T36W	36W / 4648 lm	1147*90*100
703-SS1707T54W	54W / 6952 lm	1707*90*100
703-SS2267T72W	72W / 9256 lm	2267*90*100

关联产品 Related products



应用参考 Application reference

Open space: 10m x 10m x 3m; reflectance (%): ceiling80/wall50/floor20/ floor ceiling walls; illuminance is the average lux level on 0.75m working surface; "H" is the fittings installation height

开放式空间: 10m x 10m x 3m; 反射率(%): 天花板 80/墙壁50/地板20; 照度为 0.75m工作面平均照度; H为灯具安装离地高度。

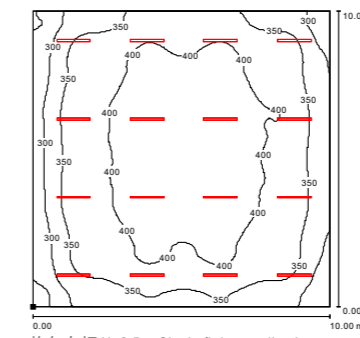

均匀布灯 H=2.5m Single fitting application

Item No	Power Flux	Number	W/m ²	H=2.8m Illuminance(Lux)
703-SS1147T36W	36W / 4608 lm	16	5.76	373