



Stark 斯塔克

451 投射灯

Projector technical data sheet

451 斯塔克系列是一款设计简洁但实用的多功能LED投射灯，灯体采用优质铝合金，粉末喷涂表面处理，坚固耐用不易变色和刮花，采用防水结构，防护等级达到IP66。使用进口高亮度COB光源，亮度高，色温一致性好。斯塔克系列有单头、双头、三头及四头多种款式，应用场所：室内室外立面、广告牌、建筑景观亮化等场所照明。

451 Stark series is one compact and multi-functional LED projector, waterproof structure is adopted, IP66, whole aluminum alloy die-cast housing in durable corrosion resistance, anti-fading and anti-scratch electrostatic powder coated finish. Imported high efficiency COB LED light source ensure great consistency of the CCT. The Stark series includes 4 types: single head, double heads, three heads, and four heads options.

Applications: Outdoor & Indoor facades, billboard, Architectural lighting etc.

产品细节 Details

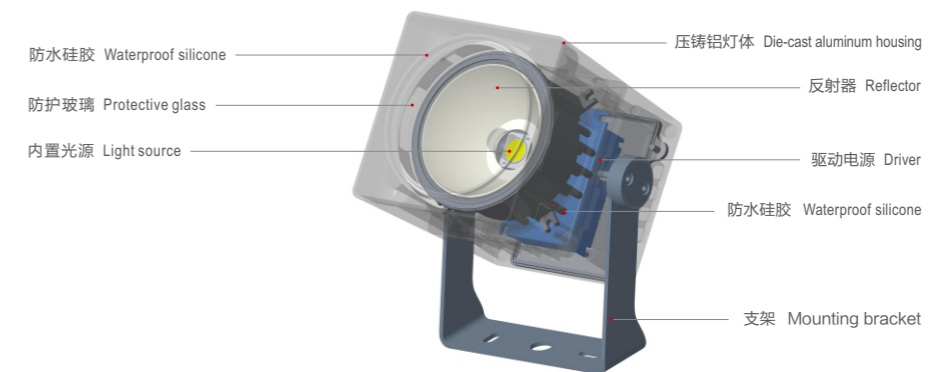

规格参数 Technical Data

名称: 451 投射灯
 类型: 投射灯
 灯体材料: 压铸铝
 表面处理: 静电喷涂
 光源: COB
 整灯光效: 70 lm/W
 显色指数: ≥80
 色温: 3000K/4000K/6500K
 输入电压: 220-240V
 驱动电源: 高转换率驱动电源
 控制组件: DMX512
 灯具寿命: 3万小时
 电气等级: II

Product name: 451 Architecture projector
 Type: Architecture projector
 Housing material: Castiron
 Surface finish: Electrostatic thermo-painting
 Light source: COB
 Lumina ire efficiency: 70 lm/W
 CRI: ≥80
 Color temperature: 3000K / 4000K / 6500K
 Input voltage: 220-240V
 Driver: High efficiency driver
 Control methods: DMX512
 Lifespan: 30000h
 Electrical grade: II



标准灯具 Standard single fitting

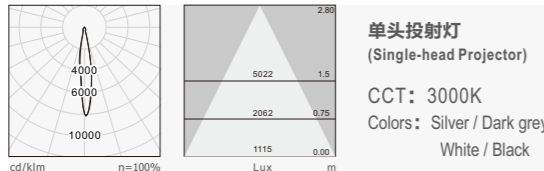
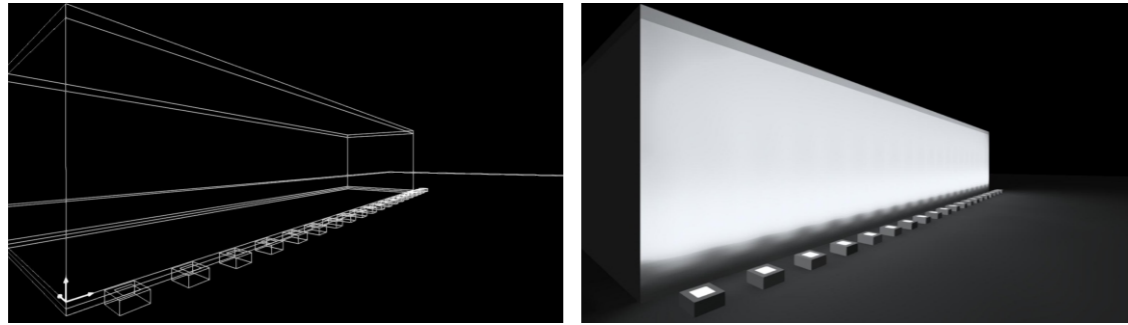

| Item No | Power Flux | Beam angle | L*W*H |
|---------------|--------------|------------|-------------|
| 451-FH130G20W | 20W /1400 lm | 12°/38° | 130*160*230 |

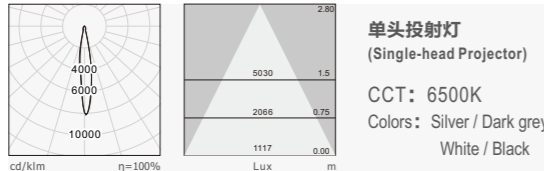
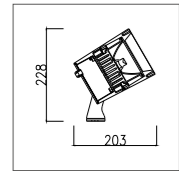
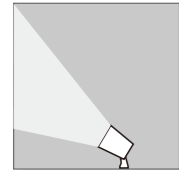

| Item No | Power Flux | Beam angle | L*W*H |
|---------------|--------------|------------|-------------|
| 451-FH130G20W | 20W /1440 lm | 12°/38° | 130*160*230 |

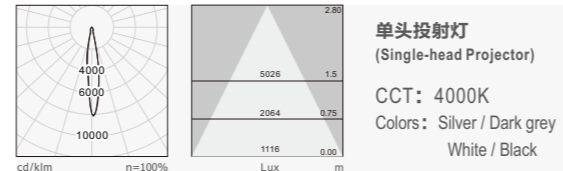

| Item No | Power Flux | Beam angle | L*W*H |
|---------------|--------------|------------|-------------|
| 451-FH130G20W | 20W /1420 lm | 12°/38° | 130*160*230 |

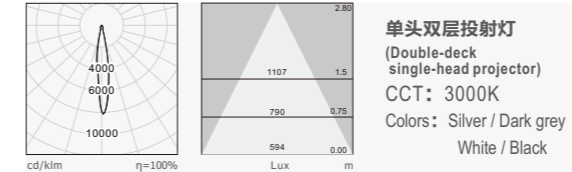

| Item No | Power Flux | Beam angle | L*W*H |
|----------------|--------------|------------|-------------|
| 451A-FH130G40W | 40W /2800 lm | 12°/38° | 130*160*400 |

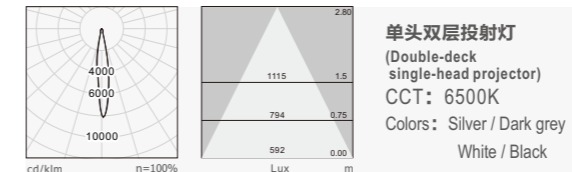
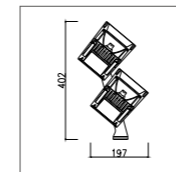
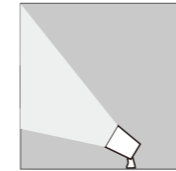

| Item No | Power Flux | Beam angle | L*W*H |
|----------------|--------------|------------|-------------|
| 451A-FH130G40W | 40W /2840 lm | 12°/38° | 130*160*400 |

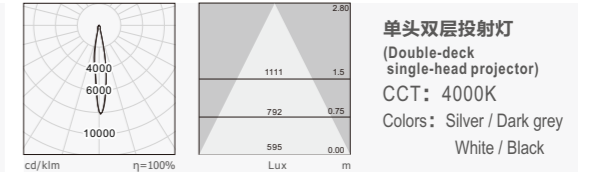

| Item No | Power Flux | Beam angle | L*W*H |
|----------------|--------------|------------|-------------|
| 451A-FH130G40W | 40W /2820 lm | 12°/38° | 130*160*400 |

关联产品 Related products



P401



P405



P409

→
Stark
斯塔克系列
451投射灯
公共场所实景图

